

Honeywell

AIR PURIFIER

Owner's manual

Please read the manual carefully before use



**AIR TOUCH V4
VALUE SERIES**

Secure Connection Limited

Flat C 61/F, Block A, LA Rossa
Coastal Skyline 12 Tung Chung
Water Front Road Tung Chung
N.T., Hong Kong
Customer Care Email:
support@honeywellconnection.com
Tel: +852 6201 9710
Web: www.honeywellconnection.com

The Honeywell trademark is used under license from Honeywell International Inc. Honeywell International Inc. makes no representations or warranties with respect to this product. This product is manufactured by Secure Connection Limited, Hong Kong.

All trade names are registered trademarks of respective manufacturers listed. ©2021 Secure Connection Ltd., Hong Kong. All rights reserved.

Honeywell

www.honeywellconnection.com
info@honeywellconnection.com

Dear Customer,

Thank you for purchasing Honeywell Air Touch V4 Air Purifier.

In order to facilitate the installation and use of this Air Purifier, we recommend that you carefully read this manual, and keep it stored safely. To ensure that you always enjoy fresh air, use this manual for qualified and standardized installation, proper use, and maintenance.

If any questions arise during use, please consult this manual. If it is in accordance with the warranty, we kindly welcome you to contact us at:

support@honeywellconnection.com

We welcome any comments or suggestions you may have about our products and service.

Contents

Performance Index	01
Product Appearance and Structure	02
Installing the Filter	03
Function Description	04
During Installation	05
Safety - Precaution for use	06
Care for your Air Purifier	07
Cleaning and Maintenance	08
Troubleshooting	09

Performance Index

Product Name	Air Touch V4
Rated Voltage	220-240V
Rated Frequency	50/60Hz
Rated Power	40W
Noise (High Speed)	56dB(A)
Noise (Low Speed)	34.4db/A
Anion Concentration	10million/cm ³
Amount of Particulate-Cleaned Air (CADR) ¹	350m ³ /h
Amount of Formaldehyde-Cleaned Air (CADR) ¹	53.5m ³ /h
Applicable Area ²	543 square feet
Suggested Period to Replace Filters ¹	<ul style="list-style-type: none">• Compound Anti-Bacterial + H13 HEPA Filter life up to 3000 hours or 1 year• Compound Cold Catalyst + Carbon Filter life up to 3000 hours or 1 year
Net Weight	4.8kg
Product Measurements	L330xW180xH505mm
Components	Compound Anti-Bacterial + H13 HEPA Filter and Compound Cold Catalyst + Carbon Filter

1. For the air that passes through the filter, Purification performance parameters are tested under specific third-party laboratory conditions with specific dust particles and formaldehyde gas as target pollutants. Overall particle reduction depends on many factors including the amount of air processed, the pollutant type and the pollutant introduction rate into the environment.

2. Air Purifier Ratings. (n.d.). Air Purifier CADR Ratings Scale | Convert Sq Ft Room to CADR. [online] Available at: <https://air-purifier-ratings.org/learn/cadr-ratings-scale/>.

Product Appearance and Structure

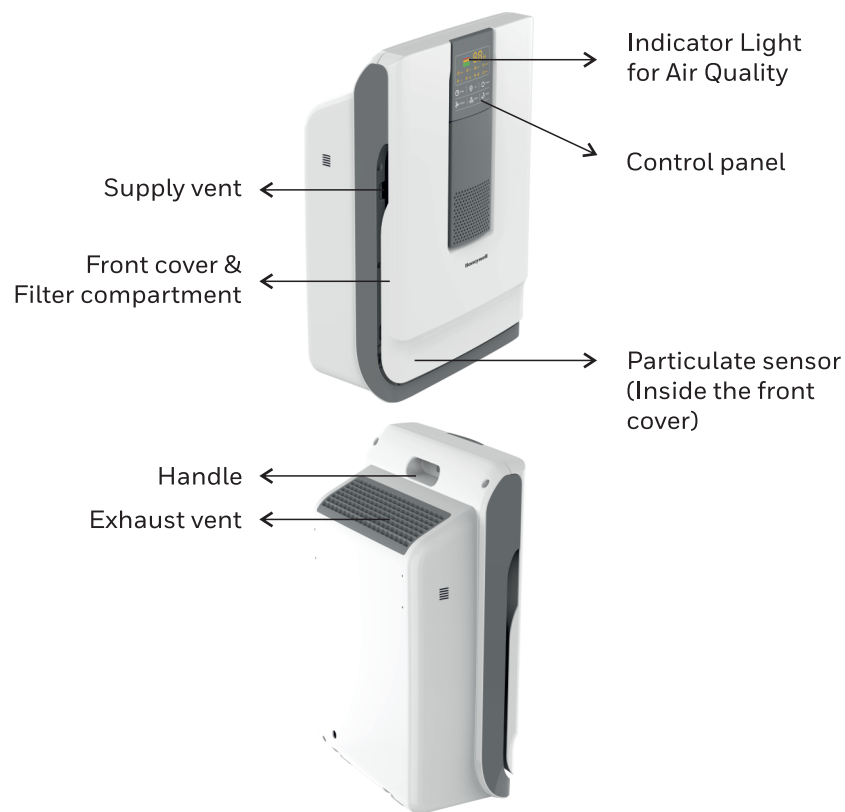

Control Panel (refer to page 4)

Installing The Filter

1. Hold the lower side of the Air Purifier front panel and lift it to remove the front cover.

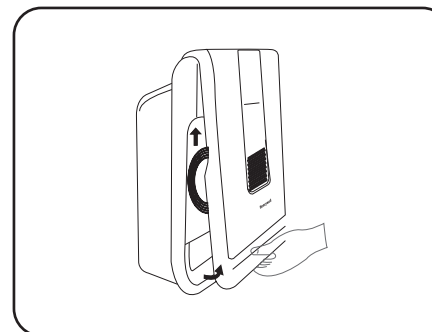

2. Turn the buckles on either sides and remove both Filters.

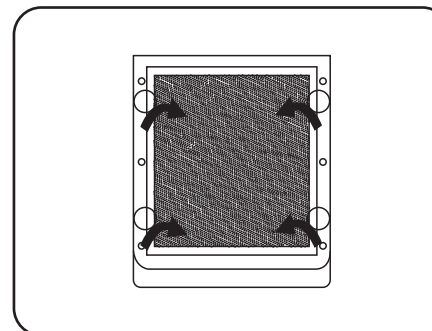

3. Take the Filter out of the packaging.

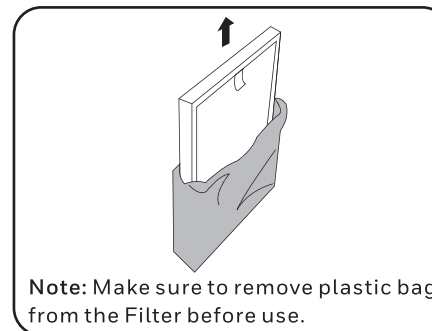

4. Place Filter 1 (Cold Catalyst and Activated Carbon Compound Filter) back into the inner side of the Air Purifier.

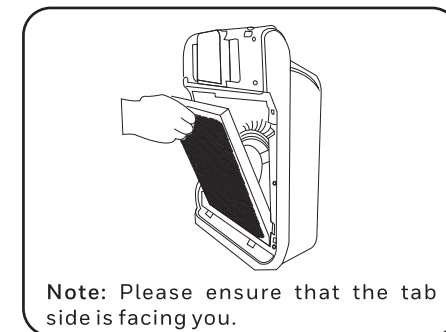

5. Place Filter 2 (Antimicrobial and HEPA Compound Filters) back after the first Filter.

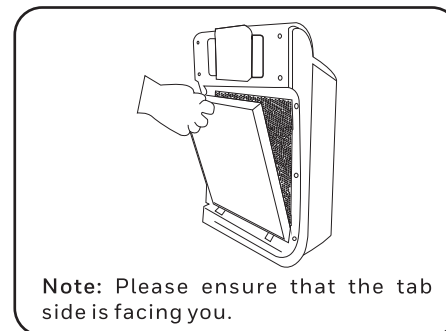

6. Close the front cover

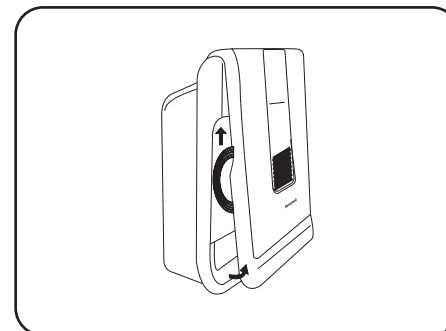

Function Description

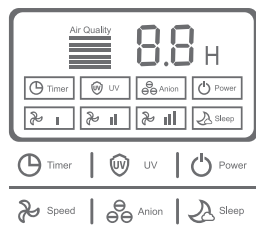

Power

When the Air Purifier is plugged in to the wall socket and is on standby, press the “POWER” button to turn on the Air Purifier. If the “POWER” button is pressed again, the Air Purifier goes into standby mode.



Speed

When the Air Purifier is powered on, press the “SPEED” button to adjust the fan speed of the Air Purifier. This Air Purifier has three fan speed levels from low to high. If the fan speed is set manually by the user then the fan speed is not controlled by the sensor and Air Purifier will operate at the fan speed set by the user. If you press the “SPEED” button for the fourth time, the Air Purifier goes into “AUTO” mode. In this mode, the Air Purifier changes the wind speed and displays the air quality status according to the current air quality.



Sleep

When the Air Purifier powered on, press the “SLEEP” button to turn this mode on or off. In “SLEEP” mode, all the lights on the control panel shall be dimmed and the Air Purifier will operate at the lowest fan speed.



Timer

When the Air Purifier is powered on, pressing the “TIMER” button adds 30 minutes or 1 hour to the timing. When timer reads 12 hours, one more press will turn it off. (The icon stays on when the Air Purifier is operating under this mode, otherwise it will be off).



Negative Ion

When the Air Purifier is powered on press the “NEGATIVE ION” button to turn the “NEGATIVE ION” function on or off. The “NEGATIVE ION” function is on by default when the Air Purifier is powered on.



UV

When the Air Purifier is powered on the “ULTRAVIOLET” * function is on by default. This function remains on in the Air Purifier always, while the Air Purifier is powered on. The “ULTRAVIOLET” LED sterilizes a variety of bacteria. The UV LED is used to purify the air by eliminating odour caused by smoke and mold. Besides, it also produces a certain number of negative ions, which freshens the air in the room while reducing the spread of certain viruses.

* Guangdong Detection Center of Microbiology, Report No 2020FM04294R01E, March 15, 2020. Results: Escherichia Coli: 99.99%, Staphylococcus Aureus: 99.99%, Candida Albicans: 99.99%. The UV LED is effective inside the Air Purifier.

Function Description (Continued)



This Air Purifier has a remote control included. This remote control is powered by a button cell. (Please take out the cell if the remote control will not be used for long periods). **Attention:** There is a one-to-one correspondence between the buttons on the remote control and the control panel. The functions and operation methods are the same. **Attention:** On first use, please take out the cell cover on the back of the remote and remove the protective film from the cell, then close the cell cover. Without removing the protective film from the cell the remote control will not work.

During Installation

1. Do not place this Air Purifier in direct sunlight or directly facing air conditioner vents or near heating appliances. It may cause the unit to warp, deteriorate, discolour or malfunction.

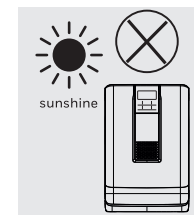

2. Do not place this Air Purifier very near TVs or Radios. This may distort images or produce noise. Using the purifier remote may cause interference with your TV or Radio. Please place at a distance of 1m or more away from these devices. In addition, If you are sharing outlets with these devices, plugging in the purifier may distort images or produce noise. If this happens, please plug the purifier into a different outlet.

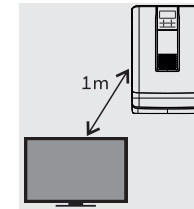

3. For effective room circulation, place this Air Purifier approximately 30cm or more away from walls or other objects. Please keep the backside of the Air Purifier at least 20cm away from the wall for effective functioning.

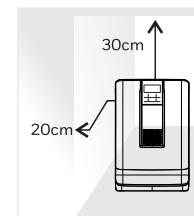

4. Do not place any items on this Air Purifier as it may lead to malfunction. Be careful not to place magnets or any other metal items on the Air Purifier.

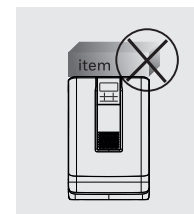

During Installation (Continued)

5. Do not block the exhaust vent or supply vent of this Air Purifier. For example, do not place an object on top of the exhaust vent or in front of the supply vent of this Air Purifier.

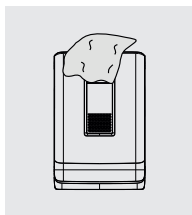

Safety - Precautions For Use

1. Do not pick up or move this Air Purifier while it is powered on. When moving or storing, do not pull the power cord. This may cause a short circuit or cause internal damage to the power cord. This may lead to a fire or electric shock. Do not cut, excessively twist, pull, or bend the power cord. If the power cord is damaged, for your safety please contact us at support@honeywellconnection.com.

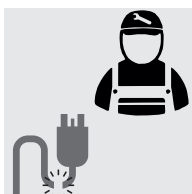

2. Use only 220V-240V AC power. Using a power source that exceeds this rating may lead to overheating and cause a fire.

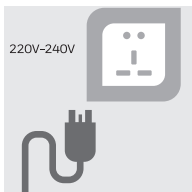

3. Do not touch the plug with wet hands while it is plugged into the wall socket. This may result in electrical shock.

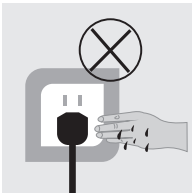

4. Do not place your fingers or metal objects into the exhaust vent or supply vent. This may cause electrical shock or injury.

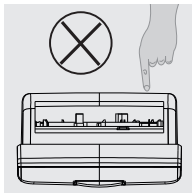

5. To avoid electrical shock or fire, do not allow water, flammable cleaners, or other liquids to enter this Air Purifier from the exhaust vent or supply vent.



Safety - Precautions For Use (Continued)

6. This Air Purifier cannot replace normal ventilation equipment, vacuum cleaners, or kitchen fans.

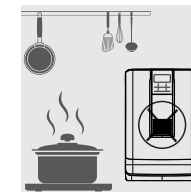

7. Please do not use this Air Purifier near gas appliances, heating appliances, or stoves.

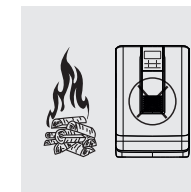

8. Do not use this Air Purifier in a humid or hot environment, such as shower or rest room or kitchen.



9. Do not place this Air Purifier up-side-down.

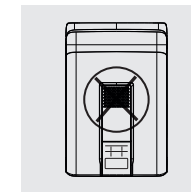

10. Do not place this Air Purifier in an unstable place, this may cause the Air Purifier to topple or fall down. This can lead to injury, electrical leakage, or fire.

11. Do not use this Air Purifier in a room that is using an incense-type insect repellent.
 - Chemical residue may accumulate in the Air Purifier and then cause harmful fumes to be released.
 - After using an insect repellent or mosquito coils, allow the room to be fully ventilated before using the Air Purifier.

Care For Your Air Purifier

1. Should any of the following conditions occur, turn off the Air Purifier immediately.
 - Strange noises or vibrations during operation
 - Air Purifier or power cord or plug is unusually hot, or has a burnt odour
 - Any other abnormalities or malfunctions

Care For Your Air Purifier (Continued)

- Please clean the plug regularly
If there is dust or moisture on the plug it could damage it. This may result in a fire.
 - Unplug the power cord, and wipe it with a dry cloth
 - Unplug the power cord from the wall socket if the Air Purifier is not going to be used for a long period of time
- Before electrical maintenance in your premises, make sure to unplug the Air Purifier from the wall socket.
- Please plug the power cord securely into the wall socket. If the plug is not securely plugged, it may cause overheating which may lead to electrical shock and even fire.
- Do not attempt to disassemble the Air Purifier, any such attempt may lead to a hazard or electrical shock or injury.

Cleaning and Maintenance

- HEPA 13 filter (approximately once every two months)

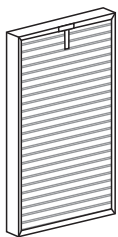

- Place the Filter in a ventilated area, this will allow harmful gasses and germs to dissipate. Do not place Filter in direct sunlight.
- Do not use water to clean this Filter

- Cellular Activated Carbon, Cold Catalyst Filter (approximately once every two months).

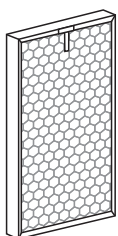

- Clean the dust from the front of the Filter with a dry cloth
- Place the Filter in a ventilated area, this will allow harmful gasses and germs to dissipate. Do not place Filter in direct sunlight.
- The Filter is delicate. Do not press too hard on the Filter while cleaning with a dry cloth.
- Do not use water to clean this Filter.

- Particulate sensor (clean approximately once every two months)

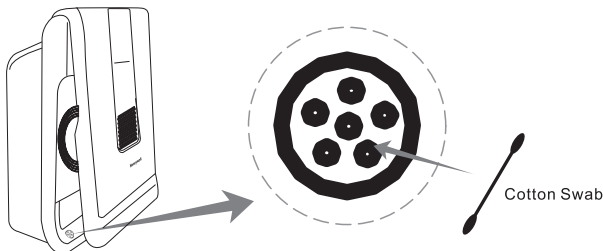

Cleaning and Maintenance (Continued)

- Wipe the lens with a dry cotton swab periodically to remove any dirt. (Moisture or tobacco smoke residue may cause it to no longer work properly).
- Do not insert the cotton swab into any area
 - Be sure to unplug the power cord from the wall socket

Troubleshooting

Common malfunctions, error code description, and troubleshooting method.

Malfunction	Inspect/How to fix
Cannot turn on power or touching any button has no response.	<p>Q. Is the power cord plugged in? A. Plug the power cord into the wall socket tightly.</p> <p>Q. Is the Air Purifier front panel open? A. Close the front panel</p> <p>Q. Is the Air Purifier stable and placed on the ground? A. Place the Air Purifier in a stable manner on the ground.</p> <p>Q. Is the Air Purifier in child-lock mode? A. If "CHILD LOCK" icon is on then hold the lock/reset button for 5 seconds to turn off the "CHILD LOCK"</p>
The air is dirty, but the air pollution indicator stays "green". The air pollution indicator remains "red" even when the Air Purifier is continuously powered on.	<p>Q. Is the Air Purifier placed in a position that is preventing effective operation? A. Change the Air Purifier placement and position.</p> <p>Q. The particulate sensor may be dirty. A. Clean the particulate sensor</p>
The Air Purifier is giving off a foul smell.	<p>A. The Filters may be dirty, please clean the Filters as per instructions in this user manual.</p> <p>A. The Filters may need replacement, please purchase new Filters.</p>
The Air Purifier has been running for a long time but has had no significant improvement in air quality.	<p>A. The protective plastic bag may not have been removed from the Filters. Remove the plastic bag from the Filter.</p> <p>A. The Filters may not be placed in the correct order. Place the Filters in correct order</p>
Machine immediately goes to "SLEEP" mode.	<p>A. Deactivate "AUTO" mode.</p>