

# Honeywell

## AIR PURIFIER

Owner's manual

Please read the manual carefully before use



---

**AIR TOUCH P1  
PLATINUM SERIES**

---

### Secure Connection Limited

Flat C 61/F, Block A, LA Rossa  
Coastal Skyline 12 Tung Chung  
Water Front Road Tung Chung  
N.T., Hong Kong  
Customer Care Email:  
support@honeywellconnection.com  
Tel: +852 6201 9710  
Web: www.honeywellconnection.com

The Honeywell trademark is used under license from Honeywell International Inc. Honeywell International Inc. makes no representations or warranties with respect to this product. This product is manufactured by Secure Connection Limited, Hong Kong.

All trade names are registered trademarks of respective manufacturers listed. ©2021 Secure Connection Ltd., Hong Kong. All rights reserved.

# Honeywell

www.honeywellconnection.com  
info@honeywellconnection.com

Dear Customer,

Thank you for purchasing Honeywell Air Touch P1 Air Purifier.

In order to facilitate the installation and use of this Air Purifier, we recommend that you carefully read this manual, and keep it stored safely. To ensure that you always enjoy fresh air, use this manual for qualified and standardized installation, proper use, and maintenance.

If any questions arise during use, please consult this manual. If it is in accordance with the warranty, we kindly welcome you to contact us at:

[support@honeywellconnection.com](mailto:support@honeywellconnection.com)

We welcome any comments or suggestions you may have about our products and service.

## Contents

Performance Index	01
Product Appearance and Structure	02
Installing the Filter	03
Function Description	04
During Installation	05
Safety - Precaution for use	06
Care for your Air Purifier	07
Cleaning and Maintenance	08
Troubleshooting	09

## Performance Index

Product Name	Air Touch P1
Rated Voltage	220V-240V
Rated Frequency	50/60Hz
Rated Power	82W
Noise ( High Speed)	54dB/A
Noise ( Low Speed)	30dB/A
Amount of Particulate-Cleaned Air (CADR) <sup>1</sup>	450m <sup>3</sup> /h
Amount of Formaldehyde-Cleaned Air (CADR) <sup>1</sup>	65.8m <sup>3</sup> /h
Applicable Area <sup>2</sup>	698 square feet
Suggested Period to Replace Filters <sup>1</sup>	3 in 1 Compound filter life up to 3000 hours or 1 year
Net Weight	5.8kg
Product Measurements	L350xW211xH525mm
Components	3 in 1 Compound filter

1. For the air that passes through the filter, Purification performance parameters are tested under specific third-party laboratory conditions with specific dust particles and formaldehyde gas as target pollutants. Overall particle reduction depends on many factors including the amount of air processed, the pollutant type and the pollutant introduction rate into the environment.

2. Air Purifier Ratings. (n.d.). Air Purifier CADR Ratings Scale | Convert Sq Ft Room to CADR. [online] Available at: <https://air-purifier-ratings.org/learn/cadr-ratings-scale/>.

## Product Appearance and Structure

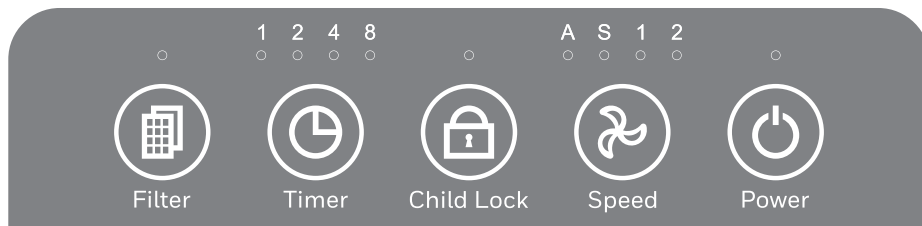
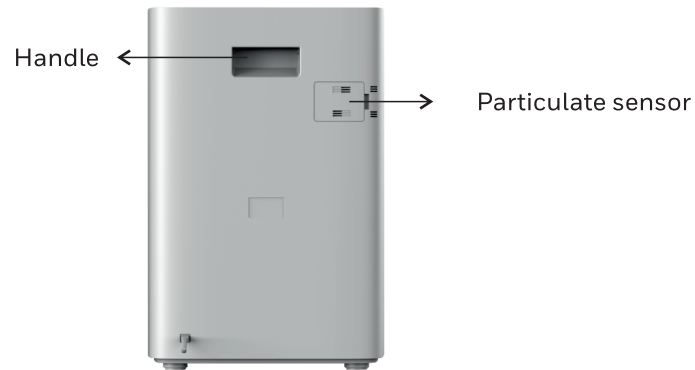
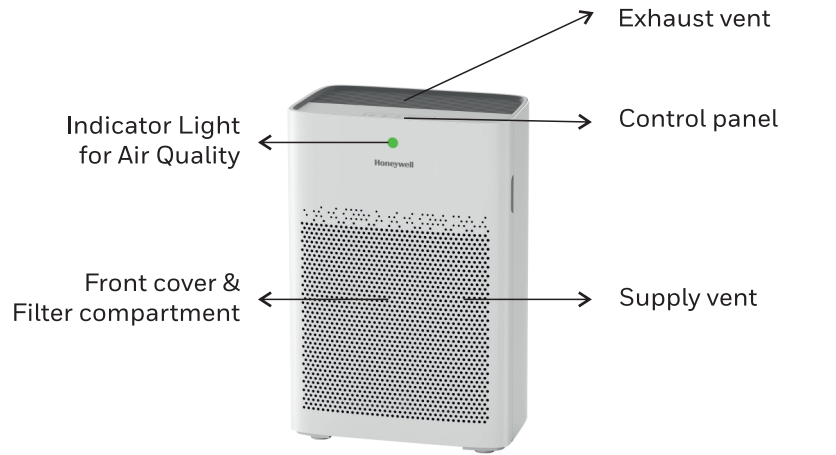

Control Panel (refer to page 4)

## Installing The Filter

1. Hold both the upper sides of the product, pull out the front panel and lift it to remove the front cover.

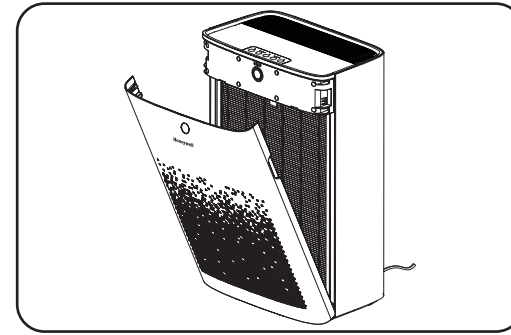

2. Take the Filter out of the Packaging.

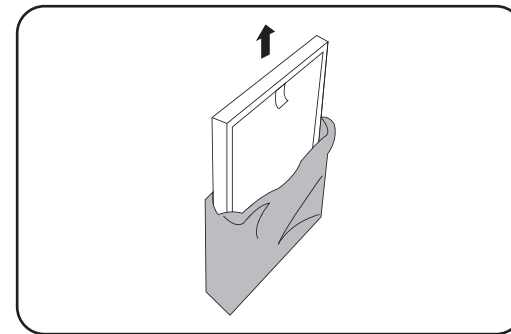

Make sure to remove plastic bag from the Filter before use.

3. Please hold the middle part of the front panel with both hands to re-install the front panel.

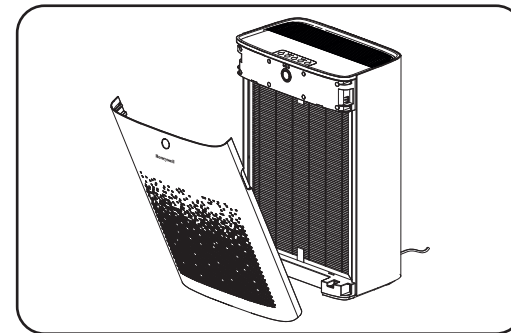

## Function Description



Power

When the Air Purifier is plugged in to the wall socket and is on standby, touch the “POWER” button to turn on the Air Purifier. If the “POWER” button is touched again, the Air Purifier goes into standby mode.



Speed

When the Air Purifier is powered on, touch the “SPEED” button to adjust the fan speed of the Air Purifier. This Air Purifier has two fan speed levels from low to high. If the fan speed is set manually by the user then the fan speed is not controlled by the sensor and Air Purifier will operate at the fan speed set by the user.



Auto

In this mode, the Air Purifier changes the wind speed and displays the air quality status according to the current air quality.



Sleep

When the Air Purifier is powered on, it will activate “SLEEP” mode 5 seconds after the “SPEED” button is touched and the indicator light against “S” turns on. In “SLEEP” mode, all the lights on the control panel shall turn off and the Air Purifier will operate at the lowest fan speed.



Child Lock

Long touch the “CHILD LOCK” button for 5 seconds to turn on or off the “CHILD LOCK” function. All buttons will be disabled while the “CHILD LOCK” is on. The Air Purifier however will continue to work in the mode it was prior to pressing the “CHILD LOCK” button.



Timer

Touch the “TIMER” button simultaneously to activate the “TIMER” function. The “TIMER” can be set for 1,2,4 and 8 hours.



Filter

**Filter reset:** when the indicator light flashes, the Filter needs replacement is required. After replacing the Filters touch the button for 5 seconds so that the Filter timer can be reset.

## During Installation

1. Do not place this Air Purifier in direct sunlight or directly facing air conditioner vents or near heating appliances. It may cause the unit to warp, deteriorate, discolour or malfunction.

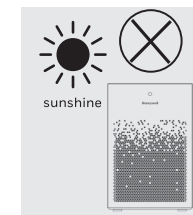

2. Do not place this Air Purifier very near TVs or Radios. This may distort images or produce noise. Using the purifier remote may cause interference with your TV or Radio. Please place at a distance of 1m or more away from these devices. In addition, If you are sharing outlets with these devices, plugging in the purifier may distort images or produce noise. If this happens, please plug the purifier into a different outlet.

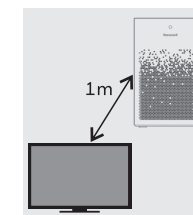

3. For effective room circulation, place this Air Purifier approximately 30cm or more away from walls or other objects. Please keep the backside of the Air Purifier at least 20cm away from the wall for effective functioning.

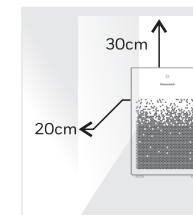

4. Do not place any items on this Air Purifier as it may lead to malfunction. Be careful not to place magnets or any other metal items on the Air Purifier.



5. Do not block the exhaust vent or supply vent of this Air Purifier. For example, do not place an object on top of the exhaust vent or in front of the supply vent of this Air Purifier.



## Safety - Precautions For Use

1. Do not pick up or move this Air Purifier while it is powered on. When moving or storing, do not pull the power cord. This may cause a short circuit or cause internal damage to the power cord. This may lead to a fire or electric shock. Do not cut, excessively twist, pull, or bend the power cord. If the power cord is damaged, for your safety please contact us at [support@honeywellconnection.com](mailto:support@honeywellconnection.com).

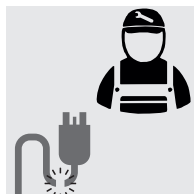

2. Use only 220V-240V AC power. Using a power source that exceeds this rating may lead to overheating and cause a fire.

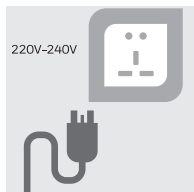

3. Do not touch the plug with wet hands while it is plugged into the wall socket. This may result in electrical shock.

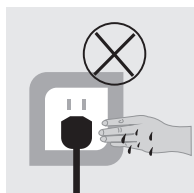

4. Do not place your fingers or metal objects into the exhaust vent or supply vent. This may cause electrical shock or injury.



5. To avoid electrical shock or fire, do not allow water, flammable cleaners, or other liquids to enter this Air Purifier from the exhaust vent or supply vent.

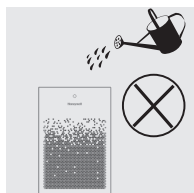

6. This Air Purifier cannot replace normal ventilation equipment, vacuum cleaners, or kitchen fans.



## Safety - Precautions For Use (Continued)

7. Please do not use this Air Purifier near gas appliances, heating appliances, or stoves.



8. Do not use this Air Purifier in a humid or hot environment, such as shower or rest room or kitchen.



9. Do not place this Air Purifier up-side-down.



10. Do not place this Air Purifier in an unstable place, this may cause the Air Purifier to topple or fall down. This can lead to injury, electrical leakage, or fire.

11. Do not use this Air Purifier in a room that is using an incense-type insect repellent.

- Chemical residue may accumulate in the Air Purifier and then cause harmful fumes to be released.
- After using an insect repellent or mosquito coils, allow the room to be fully ventilated before using the Air Purifier.

## Care For Your Air Purifier

1. Should any of the following conditions occur, turn off the Air Purifier immediately.

- Strange noises or vibrations during operation
- Air Purifier or power cord or plug is unusually hot, or has a burnt odour
- Any other abnormalities or malfunctions

2. Please clean the plug regularly

If there is dust or moisture on the plug it could damage it. This may result in a fire.

- Unplug the power cord, and wipe it with a dry cloth.
- Unplug the power cord from the wall socket if the Air Purifier is not going to be used for a long period of time

## Care For Your Air Purifier (Continued)

3. Before electrical maintenance in your premises, make sure to unplug the Air Purifier from the wall socket.
4. Please plug the power cord securely into the wall socket. If the plug is not securely plugged, it may cause overheating which may lead to electrical shock and even fire.
5. Do not attempt to disassemble the Air Purifier, any such attempt may lead to a hazard or electrical shock or injury.

## Cleaning and Maintenance

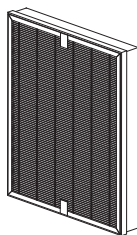

### 1. 3 in 1 Compound Filter

- Clean the surface of the sponge Pre-Filter with a dry cloth or wash with water. Allow the Pre-Filter to dry thoroughly before reuse.
- Place the Filters in a ventilated area, this will allow harmful gasses and germs to dissipate. Do not place the Filters in direct sunlight.
- Do not use water to clean the HEPA H13 & activated Carbon compound Filter
- Clean the dust from the compound filter with a dry cloth

### 2. Particulate sensor (clean approximately once every two months)

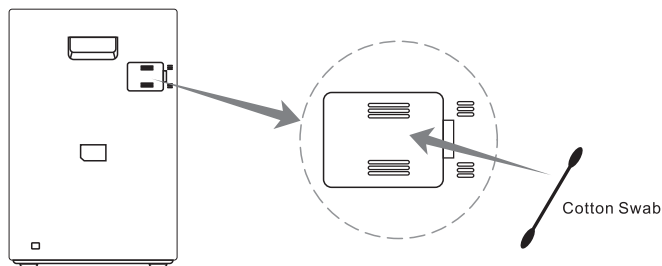

Wipe the lens with a dry cotton swab periodically to remove any dirt. (Moisture or tobacco smoke residue may cause it to no longer work properly). First remove the particulate sensor cover, use a dry cotton swab to wipe the lens.

- Do not insert the cotton swab into any area other than the lens
- Be sure to unplug the power cord from the wall socket

## Troubleshooting

Common malfunctions, error code description, and troubleshooting method.

Malfunction	Inspect/How to fix
Cannot turn on power or touching any button has no response.	<p>Q. Is the power cord plugged in? A. Plug the power cord into the wall socket tightly.</p> <p>Q. Is the Air Purifier front panel open? A. Close the front panel</p> <p>Q. Is the Air Purifier stable and placed on the ground? A. Place the Air Purifier in a stable manner on the ground.</p> <p>Q. Is the Air Purifier in child-lock mode? A. If "CHILD LOCK" icon is on then hold the lock/reset button for 5 seconds to turn off the "CHILD LOCK"</p>
The air is dirty, but the air pollution indicator stays "green". The air pollution indicator remains "red" even when the Air Purifier is continuously powered on.	<p>Q. Is the Air Purifier placed in a position that is preventing effective operation? A. Change the Air Purifier placement and position.</p> <p>Q. The particulate sensor may be dirty. A. Clean the particulate sensor</p>
The Air Purifier is giving off a foul smell.	<p>A. The Filters may be dirty, please clean the Filters as per instructions in this user manual.</p> <p>A. The Filters may need replacement, please purchase new Filters.</p>
The Air Purifier has been running for a long time but has had no significant improvement in air quality.	<p>A. The protective plastic bag may not have been removed from the Filters. Remove the plastic bag from the Filter.</p> <p>A. The Filters may not be placed in the correct order. Place the Filters in correct order</p>
Machine immediately goes to "SLEEP" mode.	<p>A. Deactivate "AUTO" mode.</p>