

Honeywell

CAR AIR PURIFIER

Owner's manual

Please read the manual carefully before use



**MOVE PURE 3
PLATINUM SERIES**

Secure Connection Limited
Flat H, 11th Floor, Tower 6,
Grand Water Front, 38 San Ma
Tau Street, To Kwa Wan,
KL, Hong Kong
Customer Care Email:
support@honeywellconnection.com
Tel.: +852 6201 9710
Web: www.honeywellconnection.com

The Honeywell Trademark is used under license from Honeywell International Inc. Honeywell International Inc. makes no representation or warranties with respect to these products. These products are manufactured by Secure Connection Limited, Hong Kong.

All trade names are registered trademarks of respective manufacturers listed. ©2023 Secure Connection Limited, Hong Kong. All rights reserved.

Honeywell

www.honeywellconnection.com
info@honeywellconnection.com

Dear Customer,

Thank you for purchasing Honeywell Move Pure 3 Car Air Purifier.

In order to facilitate the installation and use of this car air purifier, we recommend that you carefully read this manual, and keep it stored safely to ensure that you always enjoy fresh air, use this manual for qualified and standardized installation, proper use, and maintenance.

If any questions arise during use, please consult this manual. If it is in accordance with the warranty, we kindly welcome you to contact us at:

support@honeywellconnection.com

We welcome any comments or suggestions you may have about our products and service.

Contents

What's in the Box	01
Performance Index	02
Product Appearance and Structure	03
Installing the Filter	04
Function Description	05
During Installation	06
Safety – Precaution for use	07
Care for your Air Purifier	08
Cleaning and Maintenance	09
Troubleshooting	

What's in the Box

1. Move Pure 3 Car Air Purifier
2. HEPA H12 Filter with Formaldehyde Removal Crystals
3. CLA Charger
4. Mounting Accessory -Belt
5. Mounting Accessory - Non-Slip Mat
6. User Manual
7. Warranty Card
8. Thank You Card

Performance Index

Product Name	Move Pure 3 Car Air Purifier
Rated Voltage	12V
Rated Power	12W
USB Charging voltage/current	5V/3.1A
Amount of Particulate-Cleaned Air (CADR) ¹	24m ³ /h
Noise	45dB/A
Components	HEPA H12 Filter with Formaldehyde Removal Crystals
Suggested Period to Replace Filters	6-8 months of active use ¹
Net Weight	0.69kg
Product Measurements	119×119×65mm

1. For the air that passes through the filter, Purification performance parameters are tested under specific third-party laboratory conditions with specific dust particles and formaldehyde gas as target pollutants. Overall particle reduction depends on many factors including the amount of air processed, the pollutant type and the pollutant introduction rate into the environment.

Product Appearance and Structure

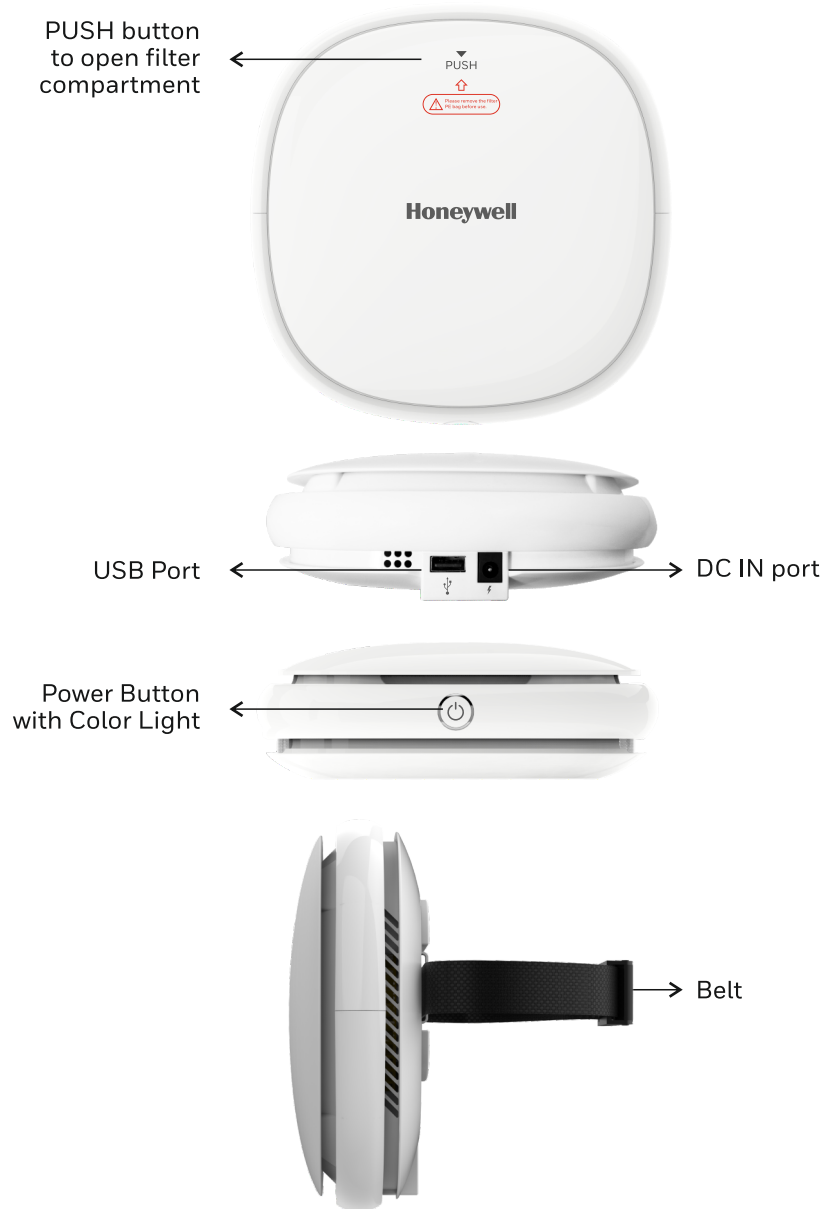

Installing The Filter

1. Press the PUSH button to open the top cover of the car air purifier.

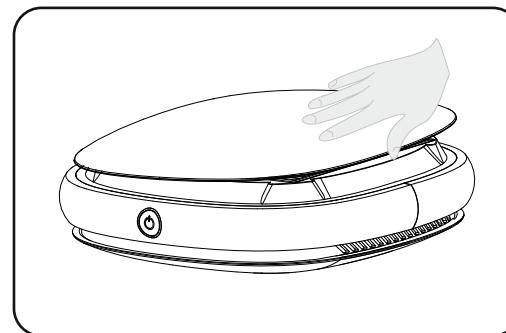

2. Please remove the protective PE bag from the filter and then place the filter back in the car air purifier before use.

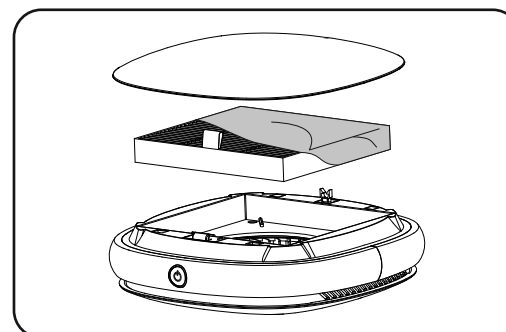

3. Place the top cover back on to the car air purifier.

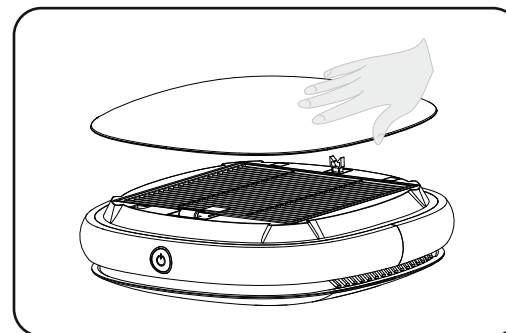

Function Description

Operation mode:



Power

When the power is switched on, the Move Pure 3 Car Air Purifier will automatically begin operating and enter the low wind speed setting by default; the indicator light will be blue during the low wind setting and become red during the high wind setting when you press the power button.



Negative Ion

Negative ion: The negative ion function is enabled by default when the machine is turned on.

A. Turn OFF the ionizer

When the machine is turned on, long pressing the power button for 5 seconds causes the blue indicator light to flash for 5 seconds, turning off the negative ion function.

B. Turn ON the ionizer

Press and hold the power button for 5 seconds causes the red indicator light to flash for 5 seconds, turning on the negative ion function once more.



Filter

Filter reset function: When the filter has to be replaced, the power indicator light flashes orange, and the filter reset function allows the user to clear the filter's record time by holding down the power button for three seconds while the device is in standby.

During Installation

1. While using the car air purifier for the first time, please ensure to open the top cover of the car air purifier, and remove the protective PE bag from the filter, and then place the filter back in the car air purifier.

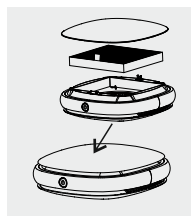

2. Insert the CLA charger to the cigarette lighter port of the vehicle and the cable of the CLA charger to the DC IN port of the car air purifier.

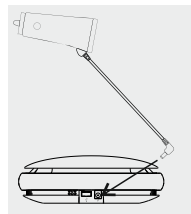

3. Please ensure that the car air purifier is placed on a dashboard or central armrest or mount on the headrest.

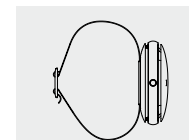

4. To charge any device please use the USB Port on the car air purifier and 2 USB Ports on the CLA charger.



3 USB Port

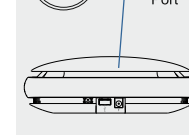

Safety - Precautions For Use

Pay attention to the following general cautions while using the product:

1. Do not use the product beyond the rated voltage (12V). Using it with incorrect voltage will damage the internal motor of the product and may cause short circuit and/or fire.

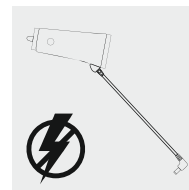

2. Do not disassemble the product. Any disassembly may cause electric leakage and injury. This will void the warranty.

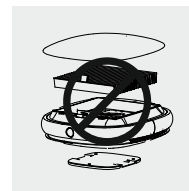

3. Please place the product on a dry flat surface for use.

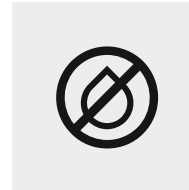

4. Use the included belt to tightly fasten the product to the headrest of the driver/co-driver seat or the central armrest.

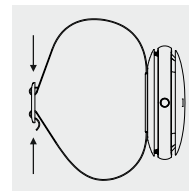

Safety - Precautions For Use (Continued)

5. The product should be turned off when being cleaned, replaced, or cleaning the filter.

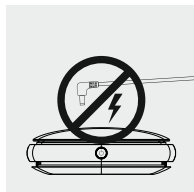

6. Do not block the air inlet or outlet while using the product to prevent damage from overheating.



7. Do not use non-original accessories or parts; doing so will void the warranty;.



8. Do not insert your fingers or other objects into the product's air outlet to prevent injury to yourself or damage to the machine.



9. When installing and replacing the filter, please remove the protective PE Bag covering from the filter.

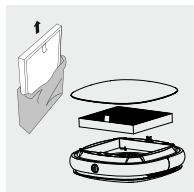

Care For Your Air Purifier

1. If the product emits an odd smell or sound, please turn it off and replace the filter if necessary before starting it up again.

2. Gasoline and other flammable detergent products cannot be used to clean this product because doing so presents a fire hazard.

Care For Your Air Purifier (Continued)

3. When the product is not in use, it is advised to place it back into the packaging box and store it in a secure, cool, and dry place, away from direct sunlight.

4. Do not use the product close to explosive materials, flammable liquids, or flammable gases.

5. Don't use the product near objects with high heat or temperature.

Cleaning and Maintenance

In order to improve the life of the car air purifier, please maintain the car air purifier on a regular basis. The maintenance can be done by following steps:

1. The filter needs to be cleaned or replaced after it has been used for 6-8 months of active use.

2. As shown in Figure A: Press the Push button on the top cover of the car air purifier so that the lock switch is jacked up and the top cover is pulled out.

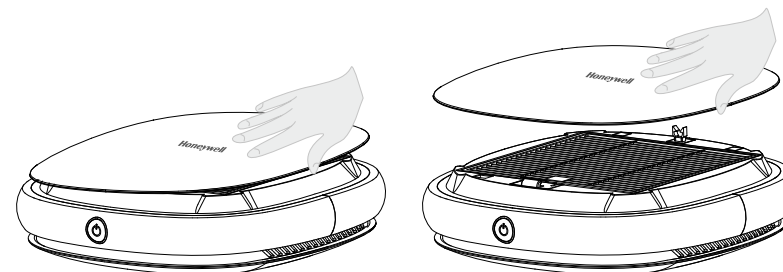

Figure A

3. As shown in Figure B: Remove the filter upwards from the car air purifier. It is advisable to clean the filter once every two weeks. A Vacuum cleaner at low speed or dry brush can be used to clean the surface of the filter

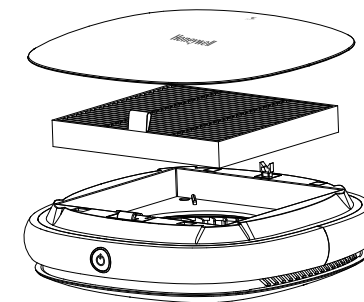

Figure B

4. Please note that the filter is not washable.

5. When cleaning the car air purifier, please power off the product and remove the CLA charger from the holder. Clean with a soft, clean and dry cloth. Do not use Alcohol, gasoline, benzene and other chemical solvents for cleaning.

Troubleshooting

Common malfunctions, error code description, and troubleshooting method.

Malfunction	Inspect/How to fix
The car air purifier cannot be turned on	<p>Q. Is the CLA Charger inserted properly? A. Check that the CLA charger is properly inserted in the cigarette lighter port in the vehicle and the cable of CLA charger is properly inserted in the DC IN port of the car air purifier.</p> <p>Q. Is the top cover of the car air purifier open? A. Please close the top cover of car air purifier</p> <p>Q. Is the car air purifier placed properly? A. Please ensure that the car air purifier is placed in a stable manner on dashboard or fastened properly to the central armrest or the headrest of the driver/co-driver seat.</p> <p>Q. The filter is incorrectly placed? A. Please re-install the filter.</p>
The car air purifier is making abnormal noise	<p>Q. Is the car air purifier being used for long hours? A. Please turn off the car air purifier and rest for 15 minutes and then restart the machine.</p> <p>Q. Is the protective PE bag on the filter removed? A. Please ensure protective PE bag is removed from the filter prior to operating the product.</p>
The car air purifier is giving foul smell	<p>A. The filter may be dirty, please clean the car air purifier as per the instructions in the manual.</p> <p>A. The filter may need replacement, please purchase a new filter.</p>